

1.0 INTRODUCTION OF THE PROJECT

Mosque Crowd Funding System (MCF) is a one of system that will help community to apply for fund. For the Mosque Crowd Funding system is to present the solution of crowdfunding by utilizing network of system mosque with Islamic compliance. This also is discussed on the solution on the risen issues for Islamic online fundraising these days. It also provides the information on utilizing the network of mosque with crowdfunding which the platform that will be develop in order to solve the issues. The platform is featuring a more secure and trusted way in online fundraising which use Quran and Sunnah as guidance. It provides with the right solution based on the Islamic guidelines since it utilizing the network of system mosque. This system was inspired from crowd funding. The system provides 24/7 services to user. This means that everyone can access to the system as long as they have internet connection and devices. The process of applying the fund will become easier by using this system.

This user that can use this system are those who need for help in term of facilities in the mosque, food, assistance for orphans, single mother and so on. Those who have financial problems about the continue study also can register to this system. While, donators can choose to who they want to donate. The target audiences for this system is communities, Non-Governmental Organization (often abbreviated **NGO**) and so on.

In order to use this system, there is a few information that need to be fill up. The information is such as full name, identification card, contact number and etc. When register the project, user need to state the purpose of applying to every mosque that they want to fund. The reason of this purpose space is for user to write why they need for fund. For example, for the any mosque that be requested about the facilities for their mosque so that the people can use every day and can make a daily activity.

2.0 DEVELOPER PROFILE



MOHAMAD IQMAL USSAIQ BIN ISMAIL

014-8446387 iqmalussaiq@gmail.com

EDUCATION

- Diploma in Information Management, UiTM Machang, Kelantan.
- Bachelor in Information Management System, UiTM Machang, Kelantan.
- Master in Information Management, UiTM Shah Alam, Selangor.

TECHNICAL SKILLS

- **Languages** : C++, HTML, PHP, JAVASCRIPT, SQL, CSS
- **Microsoft** : Word, Access, Excel, PowerPoint, Publisher
- **Adobe** : Photoshop, Dreamweaver, Flash, Illustrator
- **Operating System** : Windows, Linux

PERSONAL SKILLS

- **Languages** : English, Malay
- Good networking skills
- Excellent communication skills

EXPERIENCE

SME Corporation Malaysia (Programmer)

- Help in updating and expanding the existence programs.
- Conducting test and modifying programs.

3.0 STATEMENT OF PROBLEM

- **Financial constraint mosque**

The problems faced by the most of the mosque in Malaysia even though some of the mosque received government backing, it is still not enough. Mosque need a money to make every facility in the mosque in the best condition.

- **Trustworthy issue in the mosque.**

Another problem faced by community want to make it charity is trustworthy issue where's many reported cases about theft at burglary. Plus, there is a huge amount of the accounting rules for funds raised through crowdfunding. Donation for the needed is in dire need since current global factor is not in our side, for example the economic status is pushing the people in need of help. There are lots of channel that can be found in order to do donation as a charity act, but the trust and secure state is still ambiguous. There are hundreds of cases of misuse of this donation method, to a selfish intention.

4.0 OBJECTIVES OF THE PROJECT

Each project must have their own objectives. Same goes to MCF. There are three objectives for this system. The objectives are:

- **To save time in applying for fund**

Rather to manual way which is users need to fill up the form, get validation and wait for approval, MCF can help the user to save time in searching and applying for fund. This is because, user only need to register the account and project for funding. This obviously show that the time taken to apply for fund become shorten.

- **To provide efficient way to apply fund**

This system is an efficient platform for users to apply for mosque funding. This is because, users only need to fill up the form and wait for the donators to response to their request.

- **To help people get fund for mosque**

The process of applying for fund become easier. User that apply for fund only need to state the purpose why they need for fund. When the donators read it, the can decide either to donate or not.

5.0 SCOPE

This system is user friendly because it is easy to use. User only need to log in to the system or register if it was the first time using it. Besides that, Mosque Crowd Funding can help in getting fund in easiest way. Target audience for this system is donors and user.

Table 1: Gant chart for the system development

| YEAR | 2018 | | | | |
|--------------------------------|------|---|---|---|---|
| MONTH/ ACTIVITIES | 3 | 4 | 5 | 6 | 7 |
| PLANNING | | | | | |
| ASSIGN PROJECT | | | | | |
| DESCRIBE PROJECT SCOPE | | | | | |
| SURVEY SYSTEM REQUIREMENT | | | | | |
| RESEARCH SYSTEM | | | | | |
| DETERMINE PROJECT BENEFITS | | | | | |
| INITIATING | | | | | |
| DISCUSS ABOUT PROJECT PLANNING | | | | | |
| ANALYSIS | | | | | |
| IDENTIFY SYSTEM REQUIREMENT | | | | | |
| COLLECT AND EVALUATE DATA | | | | | |
| DESIGN | | | | | |
| DISCUSS SYSTEM DESIGN | | | | | |
| DESIGN LAYOUT | | | | | |
| DRAFT ERD, FLOWCHART | | | | | |
| IMPLEMENTATION | | | | | |
| CODING | | | | | |
| TESTING | | | | | |

| | | | | | |
|--------------------------------|--|--|--|--|--|
| INSTALLATION AND DOCUMENTATION | | | | | |
| TRAINING AND MAINTENANCE | | | | | |
| PROJECT CLOSING | | | | | |

7.0 ESTIMATED BUDGET AND COST REQUIRE FOR THE PROJECT

In order to develop this system, developer had spent some money. The money was used in order to make this system can operate well. The estimated budget and cost to develop MCF are:

Table 2: Estimated budget and cost

| ITEM | DESCRIPTION | PRICE |
|-------------------|--|------------------|
| Laptop | Lenovo G400s | RM 2, 300 |
| Wampserver | Wampserver 64bit | Free |
| Adobe Dreamweaver | Adobe Dreamweaver CS6-original and full retail version | RM 1, 200 |
| Microsoft Office | Microsoft office 2018 pro plus | RM 50 |
| Service | Completing Mosque Crowd Funding System in 30 days 1 day = RM 20 | RM 600 |
| TOTAL | | RM 4, 150 |

8.0 HARDWARE & SOFTWARE DETAILS USE IN PROJECT

8.1 HARDWARE

Table 3: Hardware used in this project

| ITEM | DESCRIPTION |
|---------------------|--|
| Laptop Lenovo G400s | <ul style="list-style-type: none"> • Intel CORE i3 7th Gen • 1 tb storage • 4 gb ddr4 memory • Windows 10 |

| | |
|---------------------------|--|
| Printer Canon L210 Series | <ul style="list-style-type: none"> • Windows XP Professional x64 Edition • Windows XP SP1 or higher (32 bit) • Windows Vista (32 bit, 64 bit) • Mac OS X 10.5.8 or later |
|---------------------------|--|

8.2 SOFTWARE

Table 4: Software used in this project

| SOFTWARE | DESCRIPTION |
|--------------------------------|--|
| Adobe Dreamweaver | A proprietary web development tool that developed by Adobe System |
| Wampserver | Refers to a software stack for Microsoft Windows operating system. Consist of Apache web server, Open SSL for SSL support, MySQL Database and PHP programming language |
| PHP my admin | An open source administration tool for MySQL and MariaDB. As a portable web application written primarily in PHP. It is one of the most popular MySQL administration tools especially for web hosting services |
| MySQL | Is an open source relational database management system. Applications that use MySQL such as WordPress and Joomla |
| Localhost | Hostname that means this computer. Used to access network services that running on host via loopback network interface |
| Portable Document Format (PDF) | To presents document, including text formatting and images, in a manner independent of software, hardware and operating system |

9.0 SYSTEM FLOWCHART

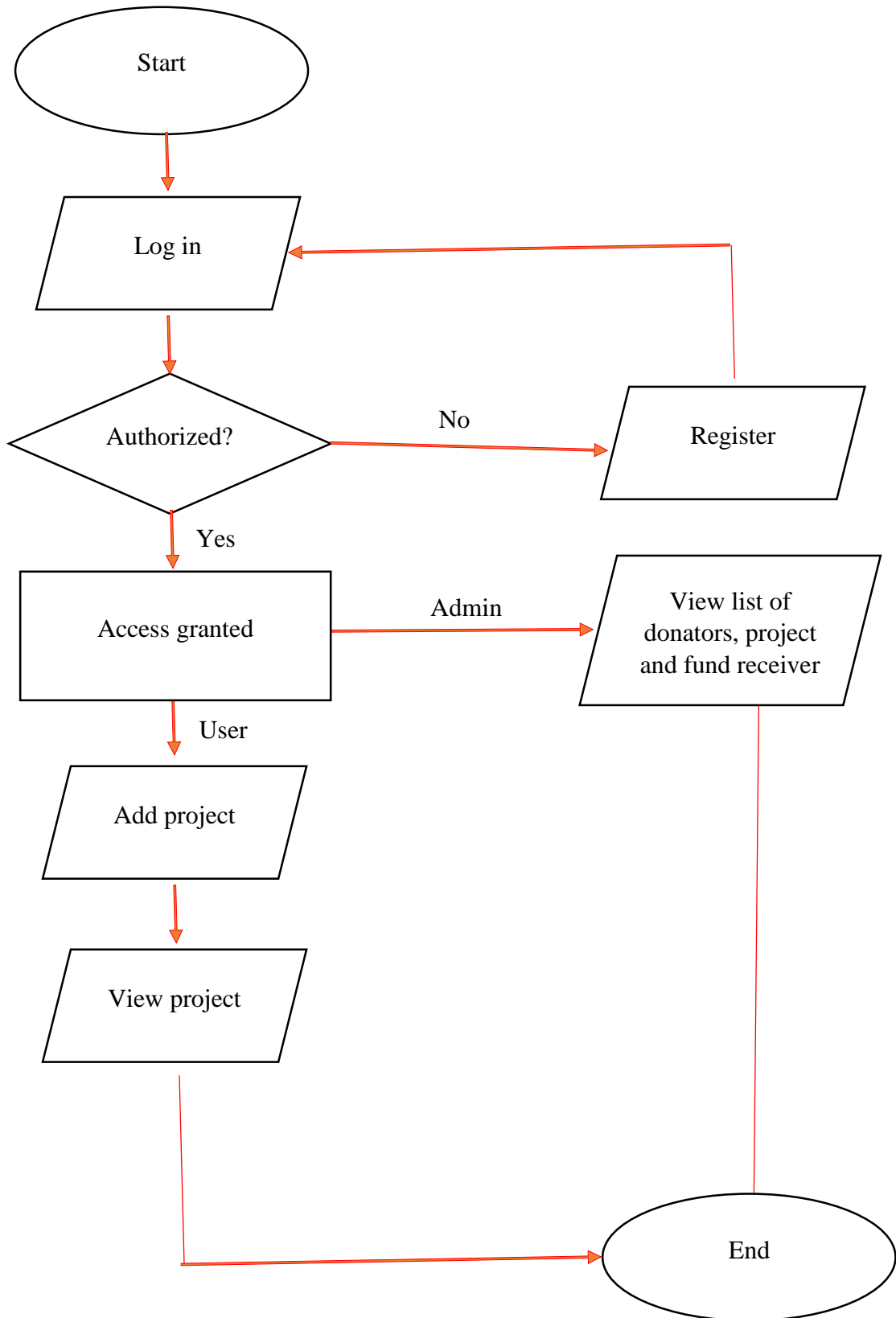

9.2 ENTITY RELATIONSHIP DIAGRAM (ERD)

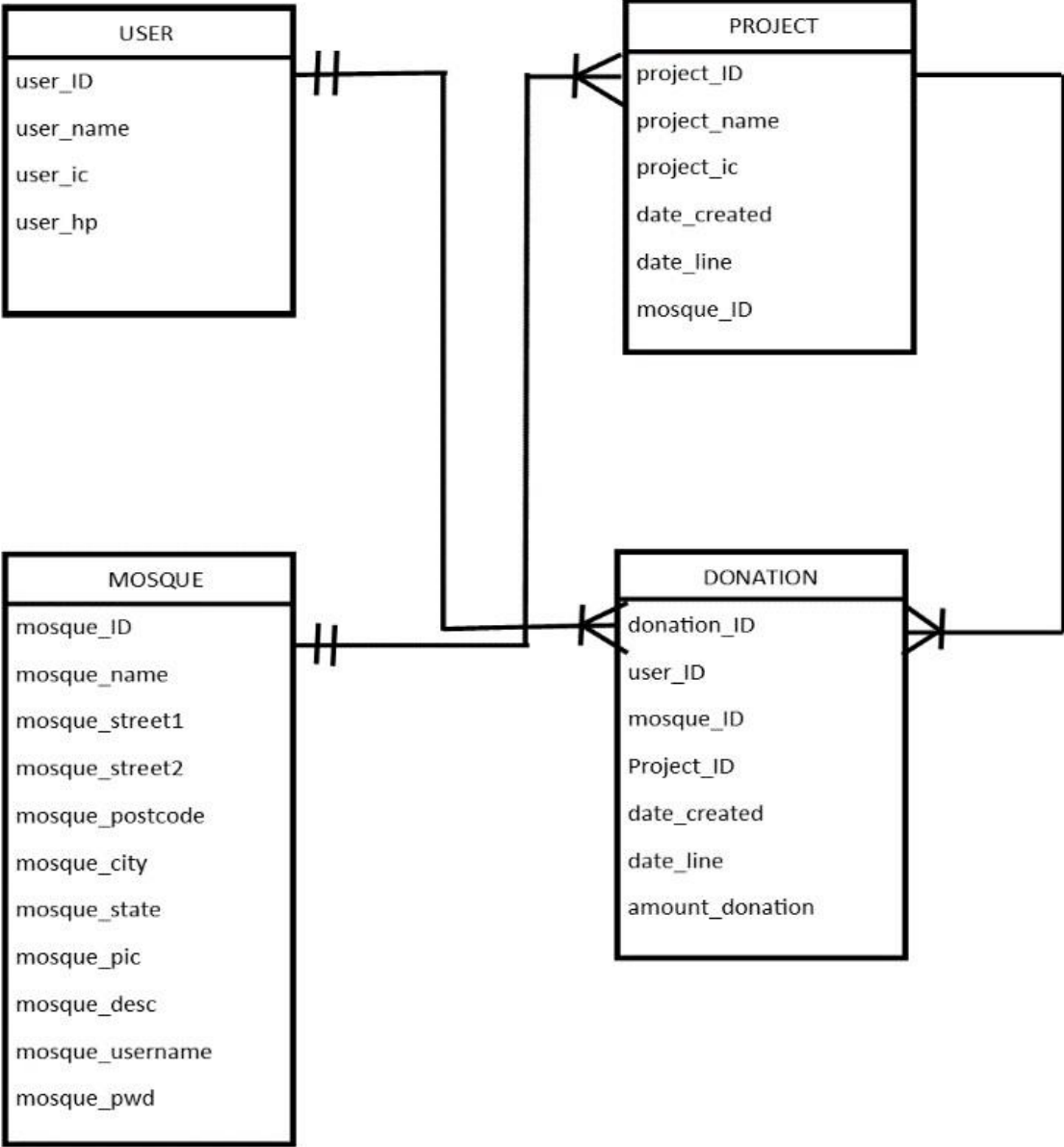

10.0 STORYBOARD, WEB SYSTEM STRUCTURE AND NAVIGATION

10.1 STORYBOARD

10.1 Login

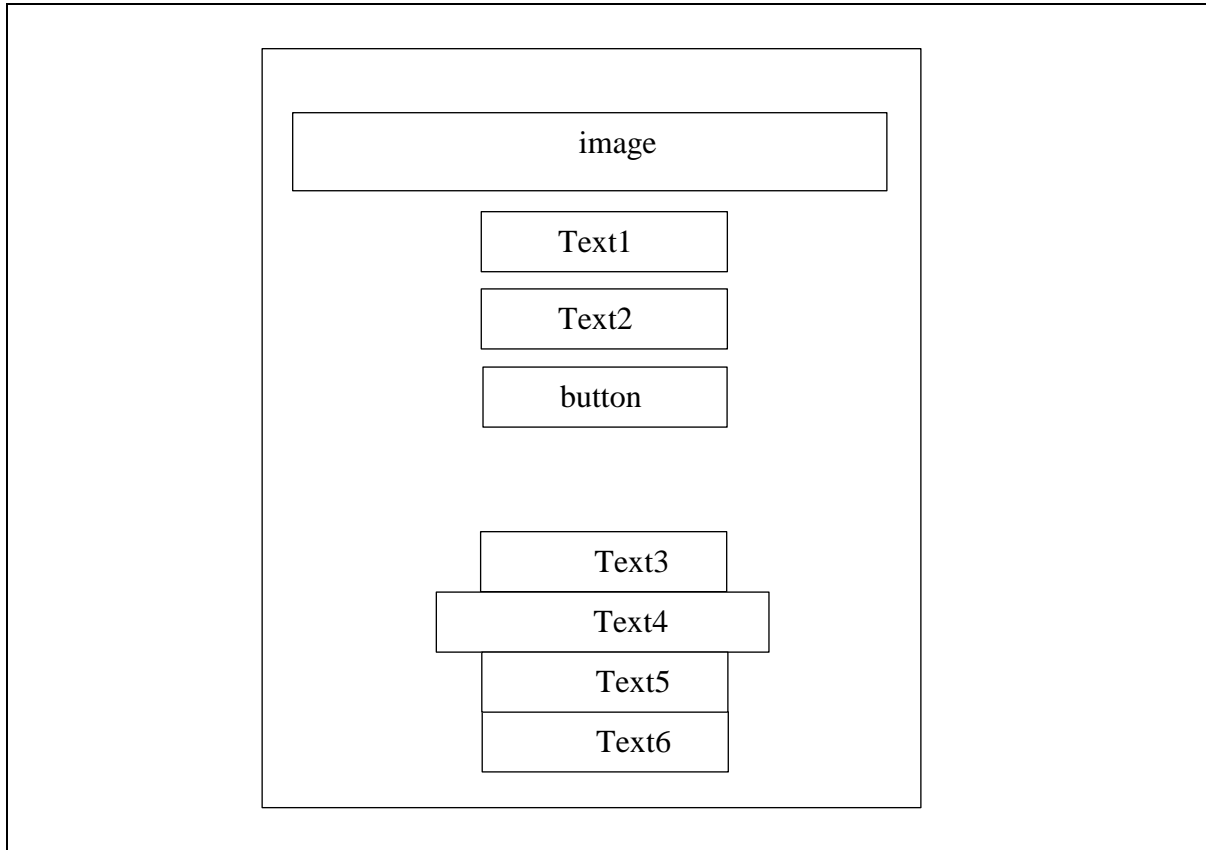

Description

Image: logo

Text1: username

Text2: password

Button: go

Text3: name

Text4: phone number

Text5: email

Text6: surname

10.2 Main page

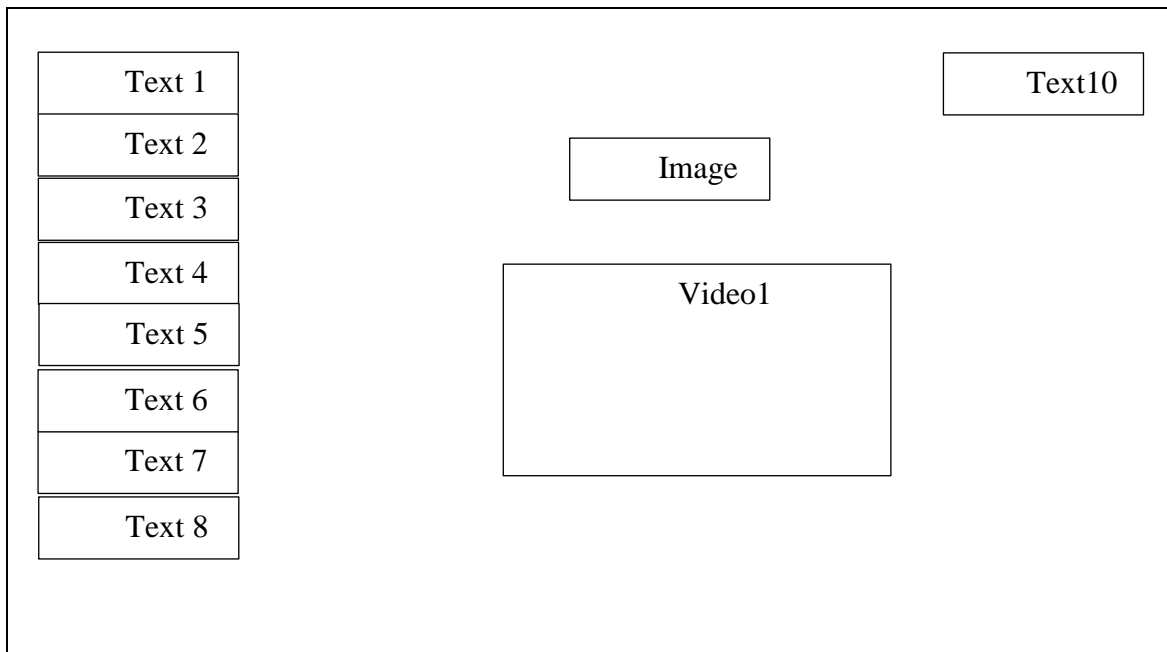

Description

Text1: mosque crowd funding

Text2: view profile

Text3: update profile

Text4: update picture

Text5: mosque

Text6: project

Text7: logout

Text8: logout,view profile

Image: logo

Video1: video of funding

10.3 Register user

The image shows a vertical stack of 12 UI elements within a rectangular frame. From top to bottom, the elements are: Text 1, Text 2, Text 3, Text 4, Text 5, Text 6, Text 7, Text 8, Text 9, Text 10, Text 11, Button 1, and Button 2.

Description

Text 1: Register here

Text 2: Username

Text 3: Password

Text 4: Name

Text 5: IC

Text 6: Address

Text 7: Postcode

Text 8: City

Text 9: State

Text 10: Phone

Text 11: Email

Button 1: Register button

Button 2: Cancel button

10.4 View profile

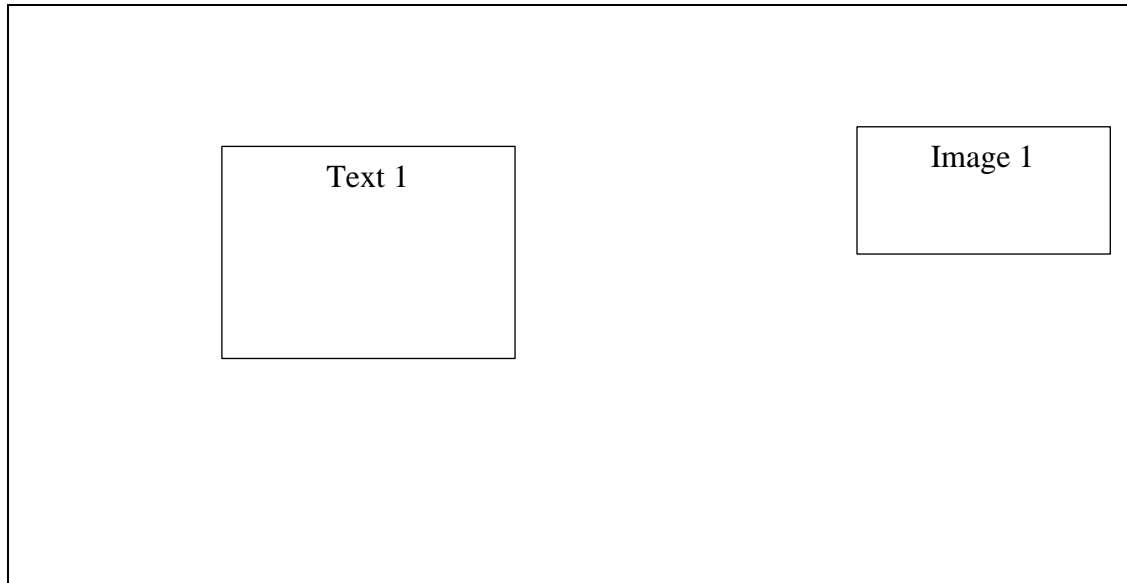

Description

Text 1: details about user

Image 1: image of user

10.5 Update profile for user

| | |
|--------|----------|
| | Image 1 |
| Text 1 | |
| | Text 6 |
| Text 2 | Text 7 |
| Text 3 | Text 8 |
| Text 4 | Text 9 |
| Text 5 | Text 10 |
| | Text 11 |
| | Text 12 |
| | Text 13 |
| | Text 14 |
| | Button 1 |

Description

Text 1: smart-diet monitoring system

Text 2: View profile

Text 3: Update profile

Text 4: List of event

Text 5: Logout

Text 6: Update of profile

Text 7: Name

Text 8: IC number

Text 9: Address

Text 10: Postcode

Text 11: City

Text 12: State

Text 13: Email

Text 14: Phone number

Button 1: Update

Image 1: image of user

10.6 Mosque

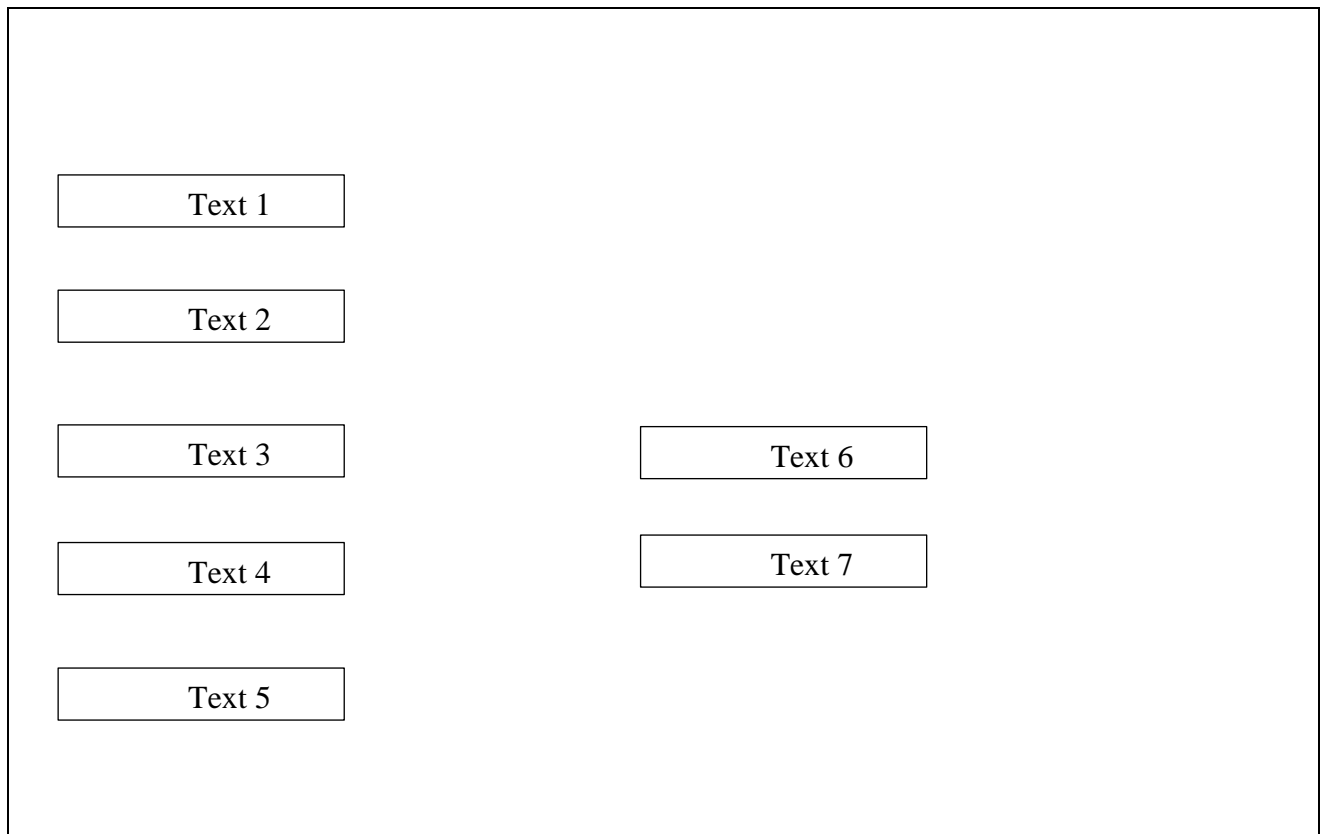

Description

Text 1: mosque crowd funding

Text 2: View profile

Text 3: Update profile

Text 4: List project

Text 5: Logout

Text 6: List of profile

Text 7: Name of project

10.7 Project

Text 1

Text 2

Text 3

Text 4

Text 5

Text 6

Text 7

Button 1

Description

Text 1: mosque crowd funding

Text 2: View profile

Text 3: Update profile

Text 4: Add of project

Text 5: List of project

Text 6: Log out

Text 7: name of mosque

Button 1: Add

10.8 Donation

| |
|--------|
| Text 1 |
| Text 2 |
| Text 3 |
| Text 4 |
| Text 5 |
| Text 6 |
| Text 7 |

Description

Text 1: mosque crowd funding

Text 2: View profile

Text 3: Update profile

Text 4: Add of donation

Text 5: List of donation

Text 6: Log out

Text 7: List of project

10.3 NAVIGATION

10.3.1 NAVIGATION (ADMIN)

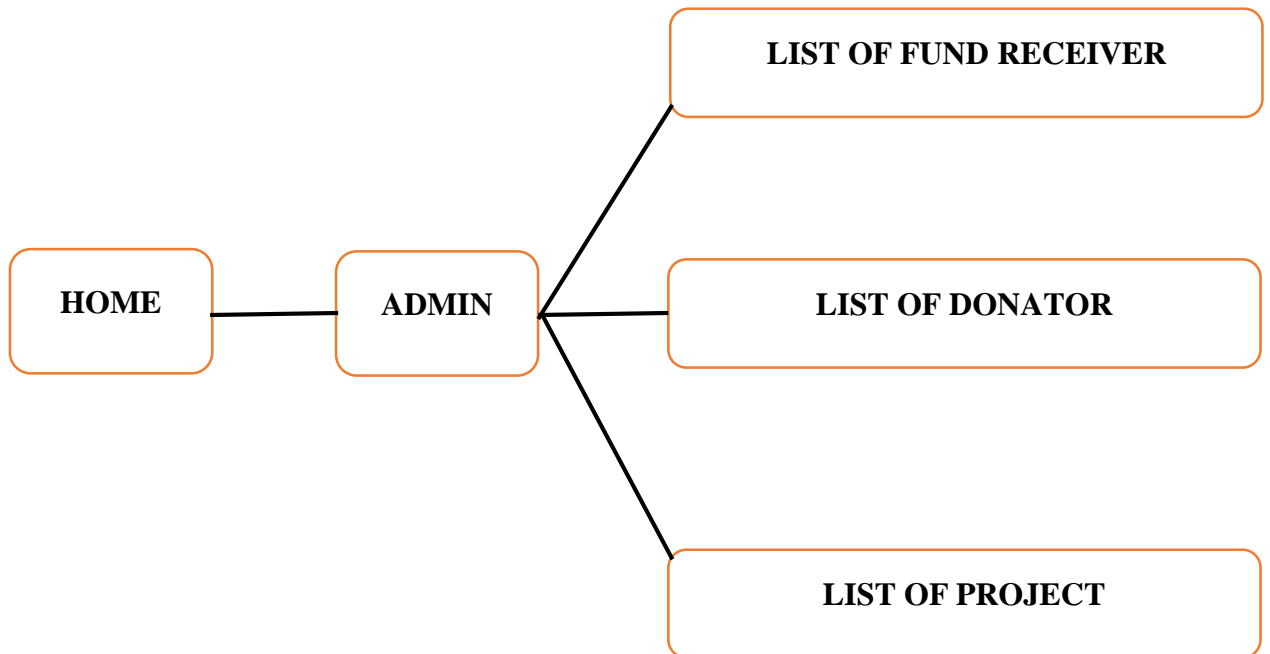

10.3.2 NAVIGATION (USER)

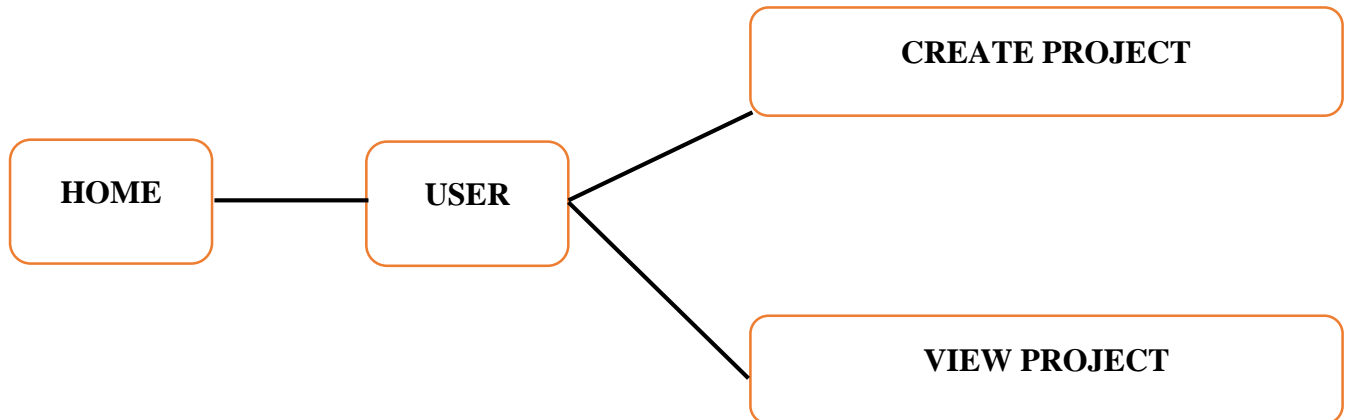

10.3.3 NAVIGATION (ABOUT US)

